

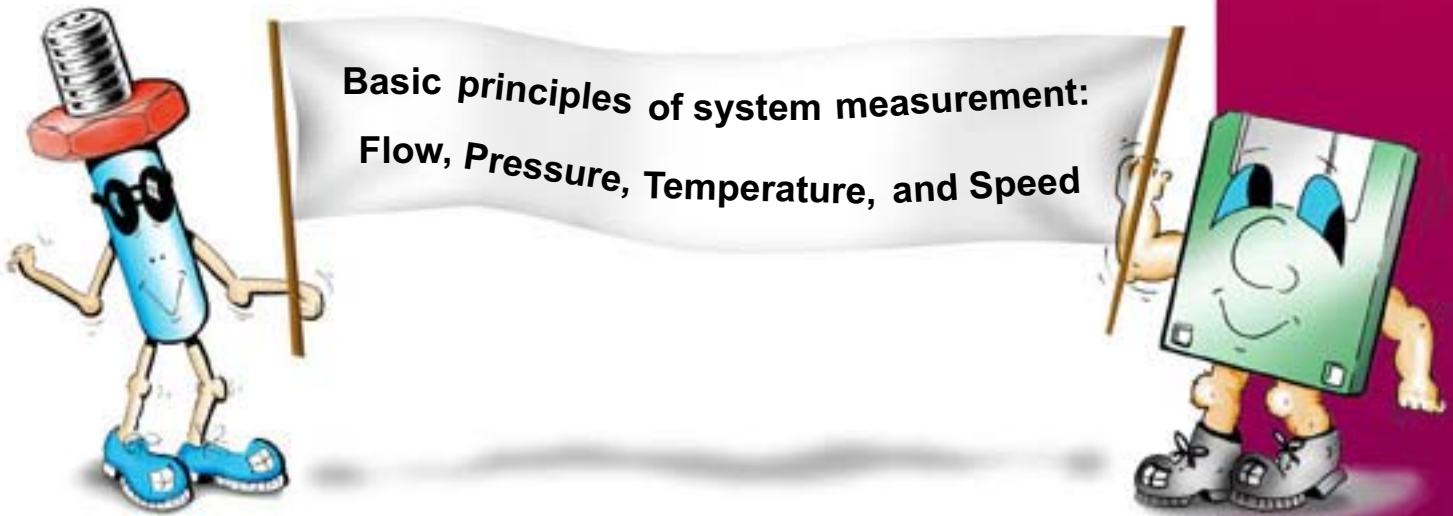

WEBTEC PRODUCTS LTD.



A short guide by Webtec Products Ltd.

January 2005

Contents

Introduction	1
Flow measurement	3
Pressure measurement	7
Temperature measurement	11
Speed measurement	15
Bibliography	19

Basic principles of system measurement: Flow, Pressure, Temperature, and Speed

'Flow and pressure measurement is to the hydraulics engineer what current and voltage measurement is to the electrical engineer'.

To know the flow rate of oil in a hydraulic system allows the engineer to monitor system performance, measure the output from the pump, consider the speed at which components operate, check for potential problems and identify internal leakage.

It is critical that you monitor the flow rate in a hydraulic system, but flow measurement will rarely be sufficient on its own. For you to successfully monitor the performance of a hydraulic system you must typically measure flow, pressure, temperature and speed on a regular basis. In addition, you will need to closely watch many other factors such as oil wear, contamination, and filtration.

The aim of this short guide is to give you a better understanding of how to carry out system measurement and give you an overview of the equipment available to the hydraulics engineer for measuring flow, pressure, temperature, and speed. This document is written as an introduction, for more detailed information please consult the bibliography at the back of this guide.

For additional technical literature and information on hydraulic training courses, contact your local fluid power association. In the UK your best contact is the BFPA or the BFPDA, and in the U.S.A. the NFPA or the FPDA.

Sensor Sam and Data Dan will illustrate some of the basic concepts throughout this short guide.



Sensor Sam

Data Dan

Flow measurement

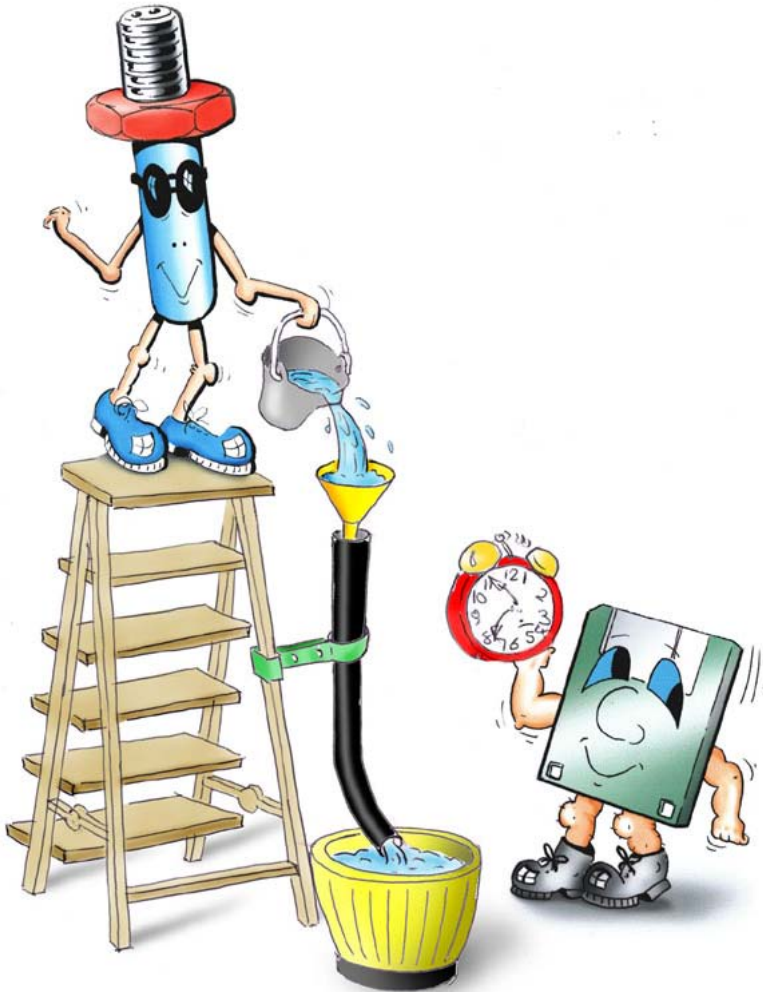

This section looks at what flow is, how you might decide which flow meter to use, and at some of the more common methods of flow measurement that are currently available.

What is flow?

Flow is the measurement of the volume of a liquid that passes a fixed point in a unit time. For most hydraulic applications, flow is measured in litres per minute (lpm), U.S. gallons per minute (US gpm), or U.K. gallons per minutes (UK gpm).

Multiply	By	To obtain
UK gpm	4.546092	lpm
US gpm	3.785412	lpm

When searching for a flow meter for use in a particular oil hydraulic application you might typically consider the following factors:

- What are the system operating conditions?
- How accurately do you need to measure flow?
- Over what range do you need to measure flow?
- What effect will the flow meter have on the fluid?
- How much will the flow meter cost?

It is important to know about the fluid you are measuring. The characteristics of the fluid can greatly influence your choice of flow meter. Of particular interest are the fluid properties (is it corrosive or a natural lubricant) and the operating pressure, temperature, and viscosity.

For some applications flow measurement is required to monitor trends, '...is the flow more or less than last week'. At other times flow measurement is required to compare performance with other systems, or against a manufacturer's specification. In the latter case, you will require far greater accuracy than in the former.

Sometimes you will only need to measure high flows of perhaps 750 lpm, at other times you will need to measure a large range of flows, between 4 and 400 lpm for example. What range will one flow meter cover, or will you need two or even three different flow meters?

The 'effect on the fluid' will depend on whether the sensor is intrusive or not and will depend on the type of mechanism the sensor uses. This 'effect' can be measured by the energy loss due to the presence of the sensor, better known as the pressure drop across the device.

Lastly the cost of the device is typically related to the accuracy, the greater the accuracy the greater the cost.

DIY flow measurement

If you had no flow meter and needed to get an idea of the flow rate, a crude way to measure flow would be to time how long it takes to fill a bucket with oil. From the volume of the bucket and the time it takes to fill it, you could calculate volume per time, or flow. Accuracy would depend on the volume of the bucket and the type of stopwatch. However, apart from being quite dangerous, the solution is not very practical; once in the bucket the oil has no kinetic energy and is exposed to contamination.

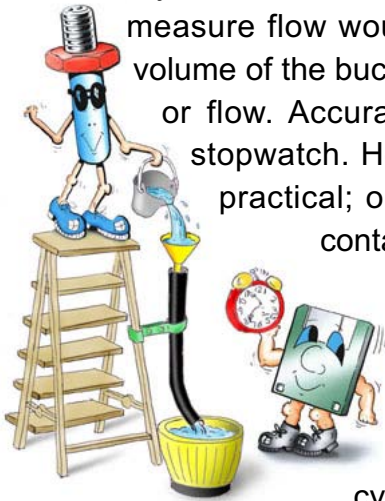

A slightly more refined method would be to connect a cylinder in series with the circuit and time how long it takes to extend. The cylinder stroke and diameter are known quantities, hence the volume and flow rate could be easily, though not particularly accurately calculated. Again, the solution is far from ideal as the cylinder has a significant pressure drop and a limited stroke.

Flow meters can be divided into five main groups and literally hundreds of subgroups; those looked at here are the types most frequently used for hydraulic flow measurement.

Variable orifice flow meters

The idea of flow displacing an object forms the basis of simple 'variable orifice' flow meters such as the **Webster Flow Indicator**. The momentum of the fluid exerts a force on a piston that is held in place by a spring. As the flow increases, the piston moves, and the orifice size increases along with the spring force on the piston. The piston is linked to the analogue readout via two magnets. The flow indicator is purely mechanical and ideal for looking at trends rather than exact measurement of flow; it typically has



Webster Flow Indicator

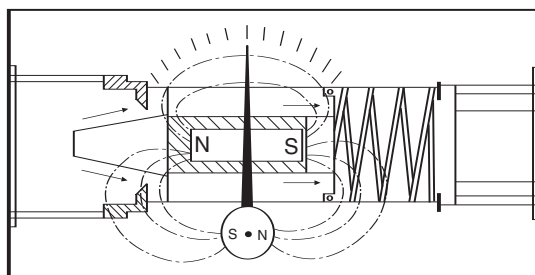

Webster Flow Indicator schematic

an accuracy of 4% of full scale. The flow indicator comes in a range of sizes; any one size will cover a 25:1 range (For example flows from 5 lpm to 120 lpm). The flow indicator offers a low cost solution with a pressure drop of about 2 bar (29 psi) at 400 lpm.

Positive displacement flow meters



Webster LT10

An alternative type of positive displacement device, the **Webster LT10** uses gears rather than a piston. Similar to a gear type motor, fluid passes around a pair of intermeshed gears, rotating the gears on their shafts. A transducer mounted above one of the gears generates a pulse each time a gear tooth passes under it. The rotation of the gears is proportional to the flow rate.

The relationship between the frequency measured by the transducer and the flow rate is given using the meter or 'K' factor (K factor = frequency / flow).

Given a constant K factor, flow can easily be calculated from the frequency. A gear type flow meter will give a more precise measure of flow than a flow indicator. The **Webster**

LT10 will operate over four times the range of a flow indicator (typically 100:1) and will measure

flow to an accuracy of within 1% of full scale. The sensor

has a pressure drop of about 9 bar (130 psi) at 10 lpm.

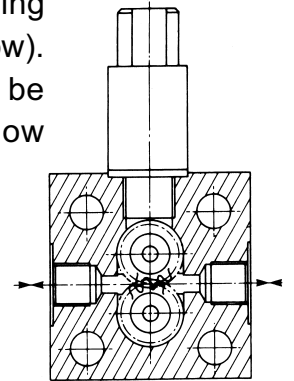

Webster LT10 schematic

Turbine type flow meters



Webster LT400

Another method of measuring flow is to use a 'rate of flow' meter such as the **Webster LT400** turbine flow meter. A turbine rotor is mounted

on a shaft between two sets of flow straighteners, the fluid passing through the flow meter rotates the turbine blade. As

for a gear-type flow meter, a transducer is mounted above the turbine and generates a pulse each time a blade passes

under it. The frequency from the transducer is proportional to flow over a limited range. For example, a 1" turbine flow

meter might typically have an accuracy of +/-1% of 300 lpm over the range of 30 to 300 lpm. This error is due to the fact

frequency is not directly proportional to flow. In order to extend the range of the flow meter and improve the accuracy, a 15-point look-

up table of K factor against flow is used. This is possible because the

flow meter is highly repeatable though

not linear in its behaviour. The same 1"

turbine flow meter when used with a look-up

table will operate over the range 10 to 400 lpm with an

accuracy of 1% of the indicated reading. If

necessary the performance can be further improved to give a 100:1 range if a different transducer is used. The use of a turbine rather

than gears or a piston means the sensor requires less energy to operate and has a very low

pressure drop, of the order of 3 bar at 400 lpm.

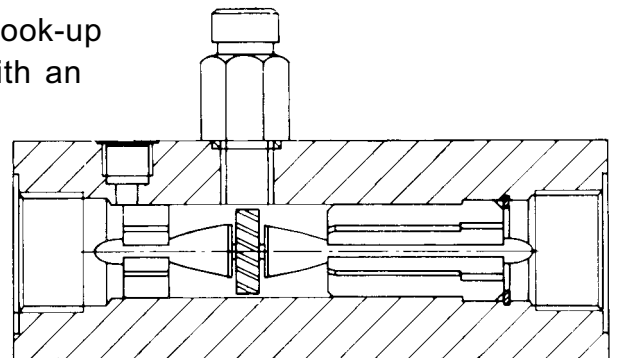

Webster LT400 schematic

ViscoCorrect™

For applications where a high degree of accuracy is required under varying operating conditions, a different approach has to be taken. As previously explained, in order to extend the range of a turbine flow meter, a look-up table is used to represent the relationship between meter factor (K factor) and flow. This relationship is true and repeatable assuming the flow meter is used under the same or very similar conditions. Where the flow meter is used at a different temperature and pressure to which it was calibrated, or where conditions are unstable, flow accuracy will deteriorate.

Research has shown that large changes in oil pressure from 1 to 400 bar will increase viscosity by about 8%. Conversely, a small change in oil temperature from 40°C to 50°C can decrease viscosity by 25%. Why does this matter? One of the main reasons behind a turbine flow meter's non-linear behaviour is oil viscosity. Viscosity adversely affects the performance of the flow meter over its whole flow range, but is most noticeable at low flows. Therefore, the relationship between K factor and flow is very different at low flows to that at high flows. One way to make a flow meter consistently accurate over a wide viscosity range and a wide flow range, is to monitor the fluid temperature as well as the turbine frequency. Then using the properties of the fluid, the oil temperature, and turbine frequency a more complex look-up table can be used to calculate the flow accurately.

The graph below shows how **ViscoCorrect™**, a system developed by **Webtec** to compensate for changes in fluid viscosity, can dramatically improve accuracy. The graph compares a turbine flow meter using K factor correction calibrated at 21 cSt with one using **ViscoCorrect™**. The test was carried out using an oil viscosity of 60 cSt. The graph clearly highlights the rapid deterioration in accuracy at lower flows if no correction is made for oil viscosity.

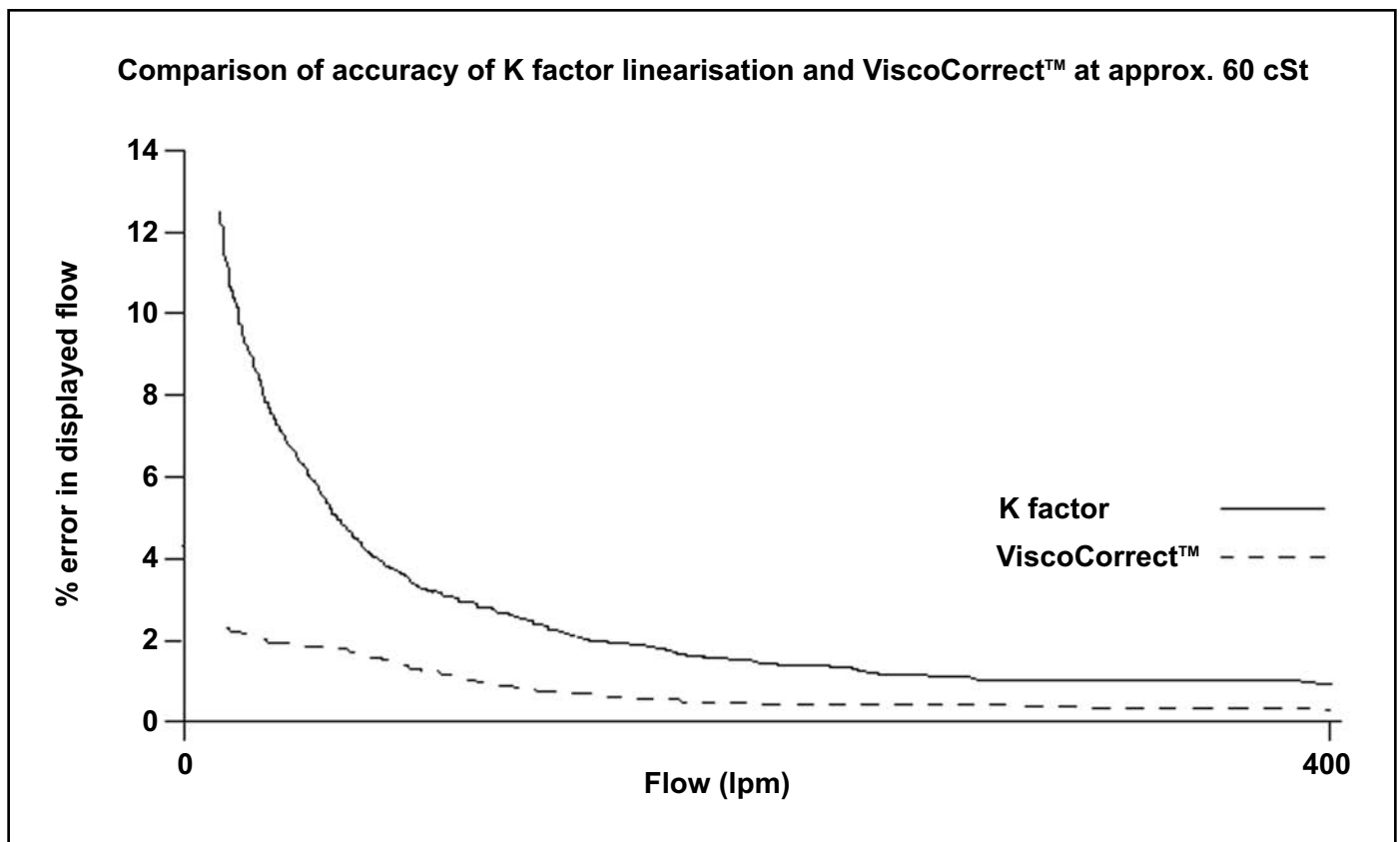

Pressure measurement



This section looks at what pressure is, how you might decide which pressure sensor to use, and at some of the more common methods of pressure measurement that are currently available.

What is pressure?

Pressure is a measure of the resistance to fluid flow. The 'pressure drop' of a flow meter is an indication of the resistance the presence of the flow meter has on the flow. For most hydraulic applications pressure is measured in bar, pounds per square inch (psi) and to a lesser extent in megapascal (MPa).

Multiply	By	To obtain
bar	14.50377	psi
MPa	10	bar

When measuring pressure in a hydraulic application you might typically consider the following factors:

- Why are you measuring pressure?
- What are the maximum and minimum pressures you need to measure?
- How accurately do you need to measure pressure?
- In what environment will you be using the device?
- How much will the device cost?

The answer to the first question might seem obvious, '...to know the oil pressure'. However are you...

1. trying to measure the pressure at one point to check the relief valve setting?
2. looking to measure the differential pressure across a device?
3. looking to measure very fast pressure spikes in the system?

The solution for scenario 1 could be very different to that for 2 and 3.

Over what pressure range does the system operate, and what accuracy will you require at any one pressure? Typically, accuracy will be defined as X% of full scale. Therefore, the percentage accuracy of the indicated reading will be worse at low pressures.

Knowing how the device will be used is also important. In particular will the sensor be exposed to large changes in temperature, sudden shocks, or will it be used in a potentially explosive environment? Like many precision instruments, pressure gauges or transducers are calibrated at a fixed temperature and large changes in ambient temperature can greatly affect their accuracy. This is important to remember if the device is to be used in close proximity to a pump or within an engine enclosure. Last but by no means least, how much will the device cost.

Simple example

If the force of a fluid is used to lift an object using a cylinder, the force acting down on the cylinder will provide resistance to flow and determine the pressure within the fluid.



Liquid-column gauges

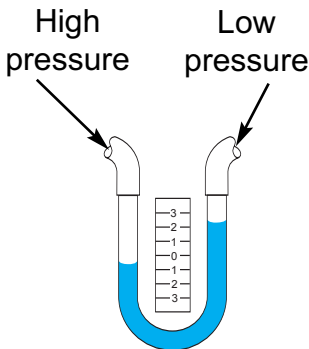

Manometer schematic

A liquid-column gauge such as a manometer or barometer contains a fluid that moves to balance the difference in pressure on each side. If one side is open to atmosphere, the manometer will measure gauge pressure. If each side is connected to a different pressure (not atmospheric), the manometer will measure differential pressure. A manometer or barometer is usually found on low-pressure applications where the maximum pressure does not exceed approximately 20 psi (1.5 bar).

Mechanical gauges

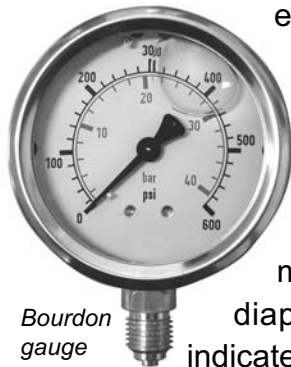

Bourdon gauge

More commonly seen are gauges using expandible metallic elements, there are three types: Bourdon, diaphragm and bellows. Normally a mechanical gauge is open to atmosphere and therefore displays gauge pressure. Typically, a change in pressure results in the movement of the tube, bellows or diaphragm that is linked to a needle that indicates a number on a scale.

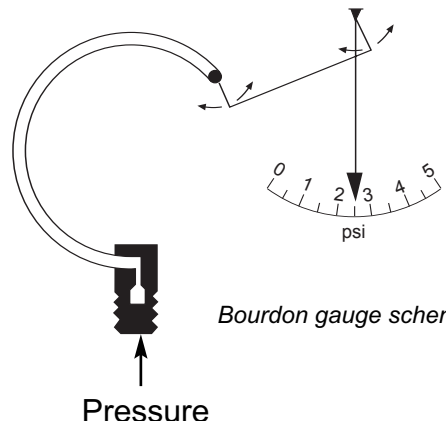

Bourdon gauge schematic

Pressure transducers

All the previous examples have been mechanical devices. However, if the signal needs to be transmitted over a long distance, or if a high degree of accuracy and fast response is critical, a pressure transducer will be used. The transducer will consist of the three parts:

1. The sensor
2. The transmission of the signal
3. The display or recording device

An electrical signal will typically be used unless there is a high risk of explosion. Electrical pressure transducers are classified by their sensing method. These include resistive, strain gauge, magnetic, crystal, capacitive, and resonant.

The **Webster LPT** range is typical of a strain gauge type pressure transducer. The transducers are available up to 400 bar, accurate to $\pm 0.25\%$ of full scale, and can be subjected to up to 1.5 times over-pressurisation. These factors make the LPT range of transducers ideal for use in high-pressure hydraulic systems.



Webster LPT Pressure Transducer

Differential pressure



Webster DPM200

Until now, we have focused on the measurement of gauge pressure. Often though, it is necessary to use pairs of pressure sensors to measure differential pressure, for example to measure the pressure drop across a device. Measuring differential pressure accurately has some inherent problems, particularly if you wish to measure a small differential between two high pressures. Take two transducers, each 400 bar with an accuracy of $\pm 0.25\%$ of full scale. If one reads 100 bar ± 1 bar, and the other 110 bar ± 1 bar, the differential pressure will be 10 bar ± 2 bar, equivalent to an accuracy of $\pm 20\%$ of the indicated reading. Clearly comparing the readings from two pressure transducers may not be sufficient by itself. The **Webster DPM** was designed to maximise accuracy when measuring differential pressure.

The device includes a pair of built-in 400 bar transducers and calculates differential pressure to an accuracy of better than $\pm 3\%$ of the indicated reading. The DPM maximises accuracy by using a microprocessor to linearise and process the readings and by ensuring the transducers are kept at a similar temperature.

and process the readings and by ensuring the transducers are kept at a similar temperature.

Rapid changes in pressure

The last parameter to mention when measuring pressure, is response time. The sensor response must be faster than the shortest period you are trying to measure. Given a pressure transducer, such as the **Webster LPT** coupled to the **Webster MC100** high-speed datalogger, a system engineer can capture and record pressure spikes lasting less than 1 millisecond (ms), an invaluable tool when faultfinding.



Webster MC100

Temperature measurement



This section looks at what temperature is, how you might decide which temperature sensor to use, and at some of the more common methods of temperature measurement that are currently available.

What is temperature?

Temperature is a measure of the 'hotness' or 'coldness' of a fluid. For most hydraulic applications, temperature is measured in degrees Celsius ($^{\circ}\text{C}$), degrees Fahrenheit ($^{\circ}\text{F}$), and occasionally it is necessary to relate degrees Celsius to degrees Kelvin ($^{\circ}\text{K}$).

From	Use	To obtain
$^{\circ}\text{C}$	$^{\circ}\text{F} = (1.8^{\circ}\text{C}) + 32$	$^{\circ}\text{F}$
$^{\circ}\text{F}$	$^{\circ}\text{C} = (^{\circ}\text{F} - 32) / 1.8$	$^{\circ}\text{C}$
$^{\circ}\text{C}$	$^{\circ}\text{K} = ^{\circ}\text{C} + 273.15$	$^{\circ}\text{K}$

When measuring temperature in an oil hydraulic application you might typically consider the following factors:

- What temperature range do you wish to measure?
- How accurately do you need to measure any particular temperature?
- What do you want to do with the measurements?
- How much will the device cost?

Typically, the majority of hydraulic systems will be run within a 20°C to 80°C temperature band. The accuracy of the required measurement will depend on the application. In some cases, temperature is used as a warning of a problem and precise measurement is not required. On the other hand, temperature might be used to specify test conditions or to indicate fluid viscosity; in this case, accuracy is far more important. Cost, as with other devices will depend on the complexity of the device, normally dictated by the required accuracy.

Simple techniques

For some applications simply touching the pipe or using a temperature sticker might be sufficiently accurate.

Liquid in a tube

If you need to measure temperature to the nearest few degrees, a simple liquid in a tube thermometer can provide an inexpensive solution. The **Webster flow indicator** incorporates a small spirit type thermometer providing a good indication of temperature.



Where greater accuracy is required or where the reading is to be displayed remotely an electrical temperature sensor is commonly used.

Electrical temperature sensors can be broken down into various groups of which the three most popular are:

1. Resistor temperature sensors, particularly thermistors
2. IC temperature sensors
3. Thermocouples

Thermistors incorporate a semiconducting material that changes resistance with a change in temperature. Typically resistance decreases with an increase in temperature, that is they have a negative temperature coefficient (NTC), though occasionally sensors with a positive temperature coefficient are used (PTC). The devices are very repeatable but the relationship between temperature and resistance is non-linear. The output voltage, a function of the resistance, is used to look-up the correct temperature from a pre-configured linearisation table. The **Webster TP200** is an example of a NTC thermistor providing accurate temperature measurement over a 0°C to 120°C range.

IC type temperature sensors supply an output current proportional to absolute temperature. Unlike the thermistor, the output is linear and therefore no look-up table is required. The **Webster TP100** is an example of an IC type temperature sensor and provides an economic solution with excellent accuracy over a -55°C to 150°C temperature range. The transducer is not affected by the use of long cables and unlike a thermocouple requires no correction factor.

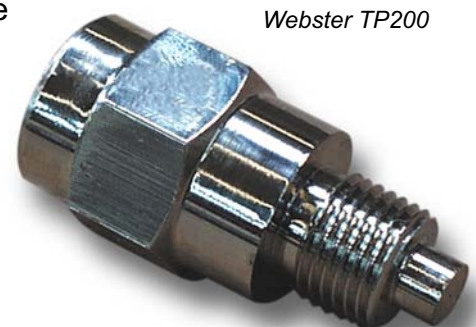

Webster TP200

Thermocouples provide an output voltage that changes due to the effect of temperature on the junction between two dissimilar metals - similar to a mini bimetallic strip. The two strips are just joined at the ends: one end is the 'measuring junction' the other end is the 'reference' or 'cold junction'. The device works by comparing the temperature effect on the two junctions; one junction will be exposed to the temperature being measured, while the other end will be kept at a reference temperature. The reference temperature must be kept

constant and 'cold junction compensation' (CJC) must then be applied to the output voltage. Sometimes an IC type sensor will be incorporated within the design to measure the reference temperature for CJC. Thermocouples are widely used in the process industry as they are ideal for high temperature applications.

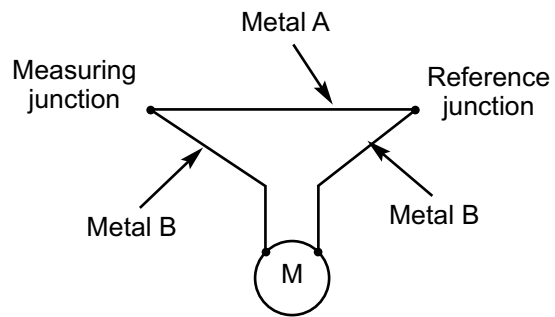

Thermocouple schematic

Speed measurement

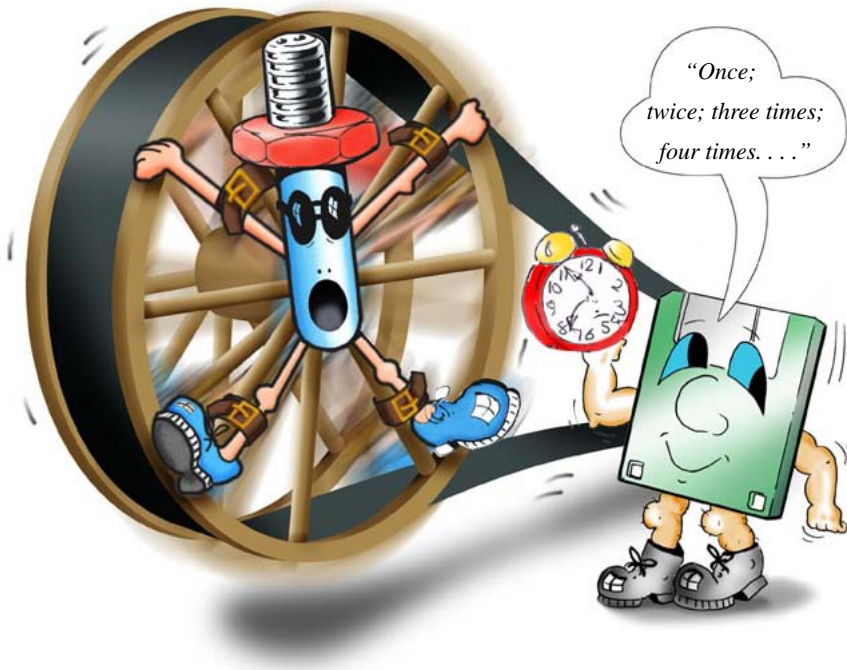

This section looks at what speed is in a hydraulic context, how you might decide which speed sensor to use, and at some of the more common methods of speed measurement that are currently available.

What is speed?

Here we are normally only considering rotational speed or frequency of rotation, defined as the number of rotations per unit time. For most hydraulic applications speed is measured in Hertz (Hz), revolutions per second (rps), or revolutions per minute (rpm).

Multiply	By	To obtain
Hz	$\text{rpm} = 60\text{Hz} / n^*$	rpm
rps	60	rpm

**n is the number of pulses generated per revolution, for example the number of teeth on a gear*

When measuring the speed of operation of a device in a hydraulic application you might typically consider the following factors:

- Where are you measuring speed?
- What range of speeds do you wish to measure?
- What do you want to do with the measurements?
- How much will the device cost?

As with all the types of measurement, it is important to know something about the object whose speed you are trying to measure. Is it made of a magnetic material? Can a sensor be placed close to it? What is the minimum and maximum speed for the application? Knowing the answers to these and the previous questions will help you choose the best sensor for your application.

Counting total number of revolutions

Where the rotating object is moving slowly over a long period of time, the number of rotations can be manually counted against time measured on a stopwatch. This is a low cost solution but obviously has certain limitations on accuracy and maximum speed. There are however a wide range of devices available designed to measure shaft speed in a hydraulic application. For the purposes of counting total number of revolutions, a mechanical totaliser provides a cheap solution.

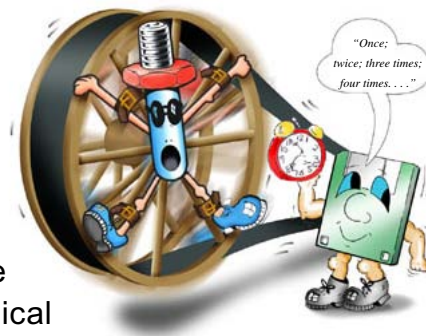

Measuring time per revolution

Where one needs a measure of the time per revolution or inversely the cycle frequency, more complex methods are required, these include:

- 1) Magnetic devices
- 2) Optical devices

Magnetic devices

The two most popular methods of magnetic frequency pick-up are variable reluctance sensors (VRS) and Hall effect sensors (HES).

Variable reluctance sensors (VRS)



Webster MT1A

The **VRS** consists of three main parts, a permanent magnet, a coil, and a pole piece.

The rotating object must be ferrite i.e. have magnetic properties. As the object, a gear tooth for example, passes the sensor the reluctance of the magnetic field changes. This change in reluctance induces a current within the coil. The frequency with which the reluctance changes is equal to the number of teeth on the gear. Because the sensor works by inducing a current it has a major benefit in that it is entirely self powered and a slight drawback in that induction will only occur over and above a minimum velocity. Therefore, the device cannot be used to measure frequencies much below 2 Hz. A variable reluctance sensor such as the **Webster MT1A** has no moving parts and offers an economic solution to speed sensing over the range of approximately 2 to 2000 Hz.

Hall effect sensors (HES)

The second type of magnetic sensor makes use of the Hall effect to sense a passing ferrite object. The HES consists of permanent magnet, a pole piece, and an IC. The IC contains two transducers capable of measuring a magnetic field differential. When a ferrite object passes the IC a pulse is generated. The advantage of the HES over the VRS is that it is not limited by a minimum operating speed and hence can measure down to zero speed.

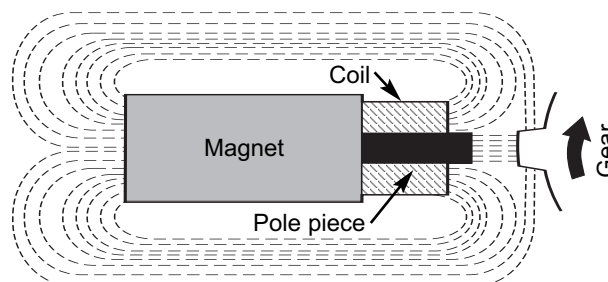

Hall effect sensor schematic

Optical devices

Photo-tachometer & IR tachometer

Where the device being measured is not magnetic or where a magnetic sensor might influence the rotation of the device, photo-tachometers provide a good alternative. The **Webster TH1A** is an example of a white light photo-tachometer. A reflective tape is attached to a point on the rotating item and a light source shone at it. The photo-tachometer incorporates a photo-conductive cell along with a white light source. When the reflective tape passes in front of the sensor, light is reflected back towards the cell. The cell resistance falls with the increase in light intensity causing the output voltage to increase. The frequency of the output voltage is equal to the frequency of rotation. Unlike a magnetic pick-up, a photo-tachometer does not have to be mounted within a few millimetres of a rotating shaft for it to work. However, if the sensor is mounted too far from the shaft it can give false readings due to interference from ambient light. One way to combat this problem is to use an infrared light source and detector, thus reducing potential interference from external lights.



Webster TH1A

Bibliography

Bernard I. C. J., Handbook of Fluid Flowmetering, Trade & Technical Press Ltd., Surrey, England, 1988.

Hayward A.T.J., FLOWMETERS A basic guide and source-book for users, The Macmillan Press Ltd., London, England, 1983.

Benedict R. P., Fundamentals of Temperature, Pressure and Flow Measurements, John Wiley & Sons, July 1984.

Macklen E. D., Thermistors, Electrochemical Publications, May 1979.



Nuffield Road, St. Ives, Cambridgeshire, PE27 3LZ, UK
Tel: +44(0)1480 397400
Fax: +44(0)1480 466555
E-mail: sales@webtec.co.uk
See us at: www.webtec.co.uk

The short guide to 'Basic principles of system measurement: Flow, Pressure, Temperature, and Speed' including all graphics are the copyright of Webtec Products Ltd. The document may be freely distributed as long as no part of it is changed and no pages are added to or removed from the original document. ViscoCorrect™ is a registered trademark of Webtec Products Ltd.
